

# WINNERS ONLY<sup>®</sup> Assembly Instructions

PROD . NO: **DBF14040**

Thank you for purchasing this quality product. Please read the instructions thoroughly before unpacking the assembly parts.

Caution: Sharp exposed staple tips can cause injury, therefore for your protection, please remove any exposed staples used in packing.

Please keep all hardware parts out of the reach of children.

1. We recommend that you should assemble this product with the assistance of another person: this will make the assembly easier, and will help to prevent personal injury and to insure parts are not damaged during the assembly process.
2. Before beginning, please check the packing materials carefully for small parts which may have come loose inside the carton during shipping. Please do not discard any packing material until all parts have been located. If any parts are missing, please contact your dealer for prompt replacement.
3. To prevent damage to your floor or carpet, please check the bottom of each piece of furniture for stain residues and rough surfaces and also check for staples or nails left after removing the packing materials. The manufacturer will not be held responsible if preventive steps are not taken prior to installation.
4. Please do not over tighten screws or bolts. During normal use everyday, screws, bolts, nuts and wooden plugs may loosen up. They should be periodically inspected and re-tightened to prevent damage to the furniture and (or) personal property of cause injury. Always check to be sure all hardware on this list and the below mentioned components are attached to the furniture properly and kept tightened.
5. Please lay all parts and hardware on a non abrasive surface such as a carpet, and follow the assembly.

This product will take 15-20 minutes to assemble.



#### Reminders

1. Use only the hardware supplied.
2. Once the product is assembled, level and tighten all the bolts.
3. Do not over-tighten bolts.
4. This item may require periodic tightening





#### NOTE:

1. Two or more people are needed for assembly
2. Please keep all hardware parts out of the reach of children.

#### COMPONENT LIST: DBF14040

NO	DESCRIPTION	SKETCH	QTY
A	Hardware Bag		1 pack
B	Table Top		1 pce
C	Table Leg		4 pcs

#### HARDWARE LIST:

NO	DESCRIPTION	SIZE	SKETCH	QTY
1	Hex Bolt	5/6" x 21/2"mm		8 pcs
2	Lock Washer	5/6" x 13.5 x 1.8mm		8 pcs
3	Flat Washer	5/6" x 22 x 1.2mm		8 pcs
4	Wrench	12.8mm		1 pce

TIP: Store the Allen key and or Wrench used in assembly in this product's drawer or use masking or painter's tape to affix it to the underside of the product. This will make it easier to find if you want to periodically tighten bolts or disassemble the product.

# WINNERS ONLY<sup>®</sup> Assembly Instructions

DBF14040

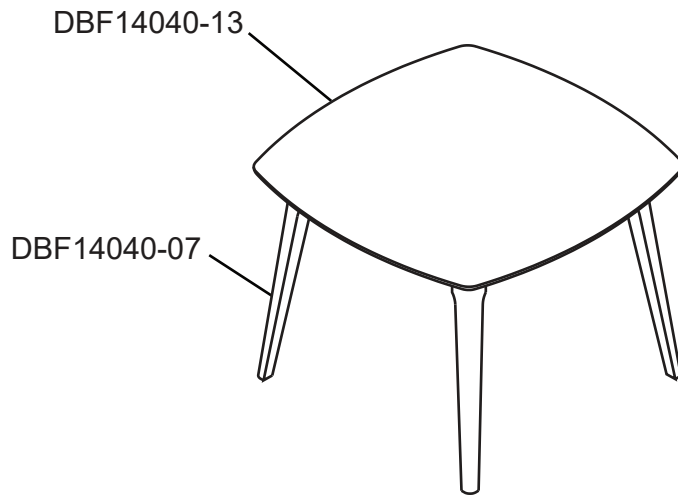

## ASSEMBLY :

### STEP 1

1.1-Turn the Table Top upside down on a soft protective surface such as carpet. Insert Table legs into Table Top using the provided hardware as shown on Fig 1.

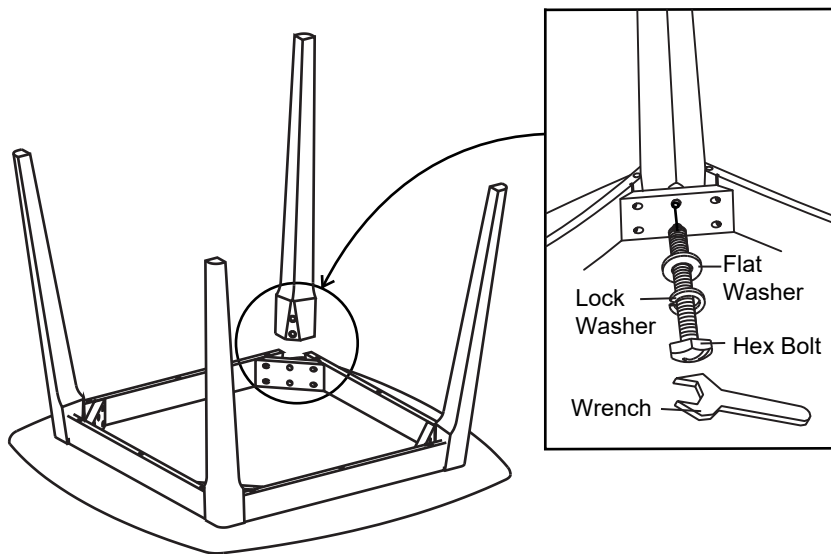

### STEP 2

2.1- Turn table to upright position.

2.2- Once table is fully balance fully tighten all bolts.

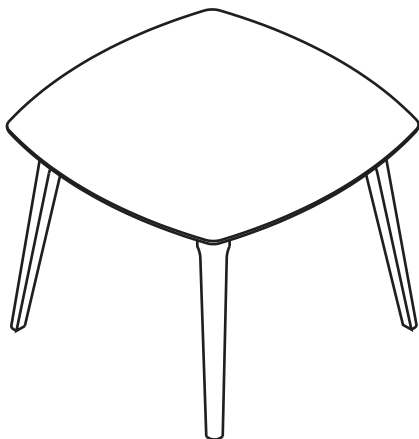

Assembly is now completed.

#### CARE INSTRUCTION

- ~ Be sure to use the same type of polish consistently. Your furniture will appear cloudy or streaky if oil based or wax based polishes are interchanged.
- ~ Spray your furniture surface evenly. Wipe in a circular motion with a soft clean cloth.