

WINNERS











ONLY INC.







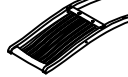

ASSEMBLY INSTRUCTIONS

PRODUCT NO: DCQ1451A

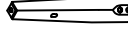
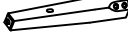
Thank you for purchasing this quality product. be sure to check all packaging material carefully for small parts that may have come loose inside the carton during shipment.

"Hardware is attached underneath the seat bottom"

Hardware List				
NO.	DESCRIPTION	SIZE	SKETCH	Q' TY
1	Allen Key	4mm		1pc
2	Allen Bolts	5/16"*3-1/8"		4pcs
3	Allen Bolts	5/16"*1-9/16"		2pcs
4	Allen Bolts	5/16"*2"		4pcs
5	Allen Bolts	1/4"*1-1/2"		4pcs
6	Spring Washers	(8mm)		14pcs
7	Flat Washers	(8*19*2mm)		12pcs
8	Wood Screw	#8*2"		4pcs
9	Wood Plug	∅16*10mm		2pcs
10	Small Washer	(8*12*2mm)		2pcs

Components List :			
NO.		DESCRIPTION	Q' TY
A		Back Rest	1pc
B		Seat Cushion	1pc
C		Seat Frame	1pc
D		Front Leg (Left)	1pc
E		Front Leg (Right)	1pc
F		Side stretcher (Left)	1pc
G		Side stretcher (Right)	1pc
H		Arm Chair (Left)	1pc
I		Arm Chair (Right)	1pc
J		Plastic Glides	4pc

Reminder

1. Use only the hardware supplied
2. Once the chair finished, leveled and tighten all bolts.
3. Do not over-tighten the bolts.
4. This item may require periodic tightening

NOTE:

1. Hardware pack is located underneath the Seat Cushion (B).
2. Two or more people are needed for assembly. Please Keep all hardware parts out of the reach of children.

Step 1: Attach the Chair Seat (B&C) to the Back Rest (A) by using Flat Washer (7). Spring Washer (6) and Bolt (2&3). Secure with Allen Key (1)

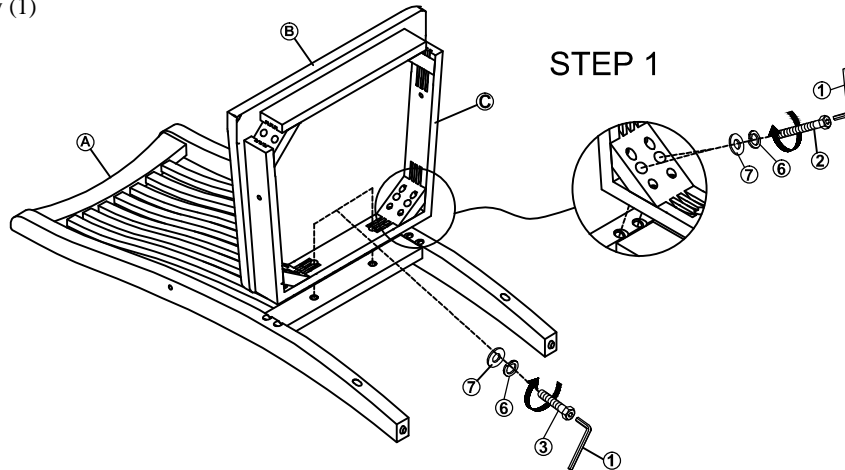

WINNERS

ONLY INC.

ASSEMBLY INSTRUCTIONS

PRODUCT NO: DCQ1451A

Step 2: Attach Side Stretcher (F&G) to Back Rest (A) using Wood Screws (8) through pre-drilled holes of Side Stretcher (F&G). Attach the Front Legs (D&E) to the Seat Frame (C) using Flat Washer (7). Spring Washer (6). Bolt (4) tighten with Allen Key (1). Attach Front Legs (D&E) to the Side Stretcher (F&G) using Wood Screws (8) through pre-drilled holes on the Side Stretcher (E&F).

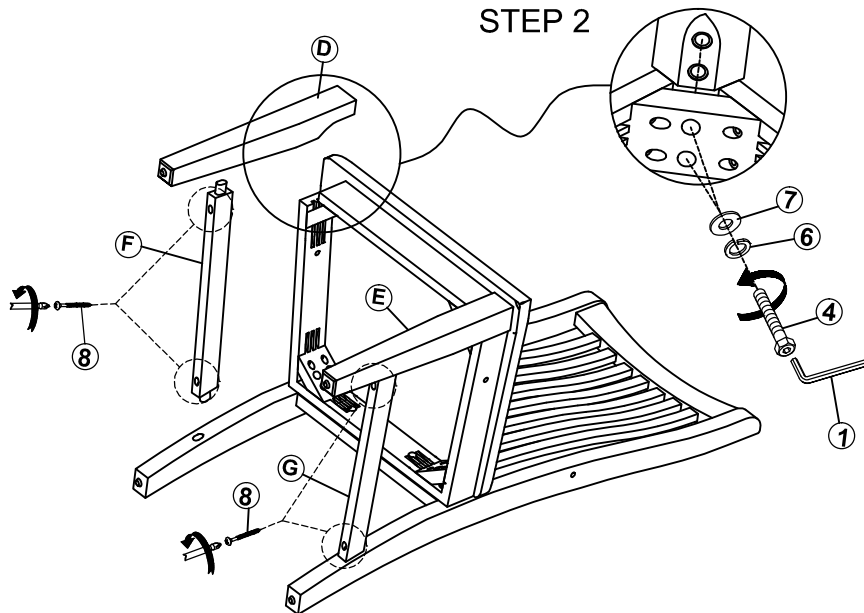

Step 3: Attach Arm Chair (H&I) to Back Rest (A) using Small Washer (10). Spring Washer (6). Bolt (5) and secure with Allen Key (1). Insert Flat Washer(7). Spring Washer (6). Bolt (5) into the holes at the Seat Frame (C). secure with Allen Key (1). Then Insert Wood Plug (9) into the holes as Picture shown. Assembly is now complete. Thank you for purchasing this product.

