

# WINNERS











ONLY INC.

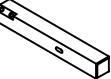
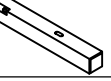

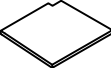
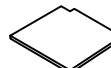



## ASSEMBLY INSTRUCTIONS

PRODUCT NO : DCQ1470B

Thank you for purchasing this quality product. be sure to check all packaging material carefully for small parts that may have come loose inside the carton during shipment.

**"Hardware is attached underneath the seat bottom"**

Components List :			
NO.		DESCRIPTION	Q' TY
A		Sideboard Top	1pcs
B		Bottom Panel	1pcs
C		Leg (Left)	2pcs
D		Leg (Right)	2pcs
E		Side Stretcher	2pcs
F		Shelf(Left)	1pcs
G		Shelf(Right)	1pcs
H		Back panel	1pcs
I		Door Handle	2pcs
J		Hand Pull	2pcs
K		Drawer Guide	4pcs
L		Door	2pcs
M		Drawer Box	2pcs

Hardware List				
NO.	DESCRIPTION	SIZE	SKETCH	Q' TY
1	Allen Key	4mm		1pc
2	Allen Bolts	5/16"*2-1/4"		8pcs
3	Allen Bolts	1/4"*1-1/2"		4pcs
4	Spring Washers	8mm		12pcs
5	Flat Washers	8*19*2mm		12pcs
6	Wood Screw	#8*1-1/2"		4pcs
7	Plastic Glides			4pc

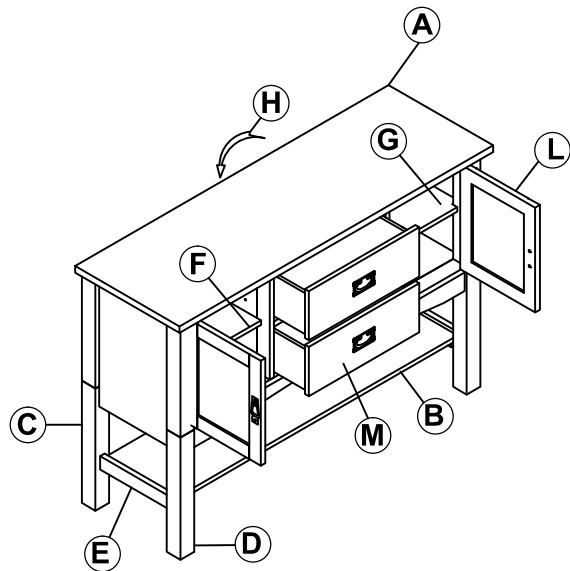

**NOTE:**

1. Two or more people are needed for assembly.
2. Please Keep all hardware parts out of the reach of children.

# WINNERS

ONLY INC.

## ASSEMBLY INSTRUCTIONS

PRODUCT NO: DCQ1470B

**Step 1:** attach Side Stretcher (E) to both Legs (C&D) using Wood Screw (6) through pr-drilled holes of Side Stretcher.

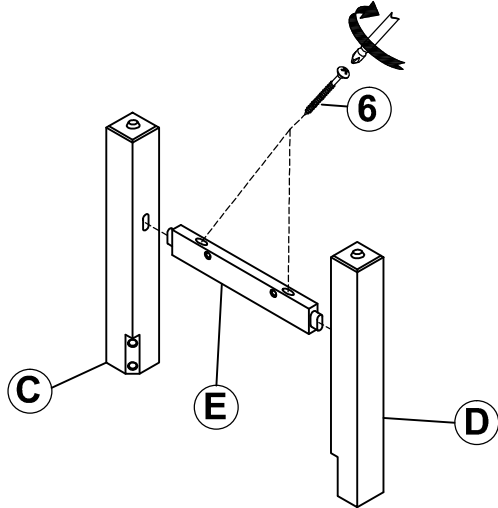

**Step 2:** Place the Sideboard Table Top flat down on a soft surface such as carpet. secure the Leg Assembly (C&D) randomly to Sideboard Top (A) using Flat Washer (5). Spring Washer (4). Bolts (2) and tighten with Allen Key (1)

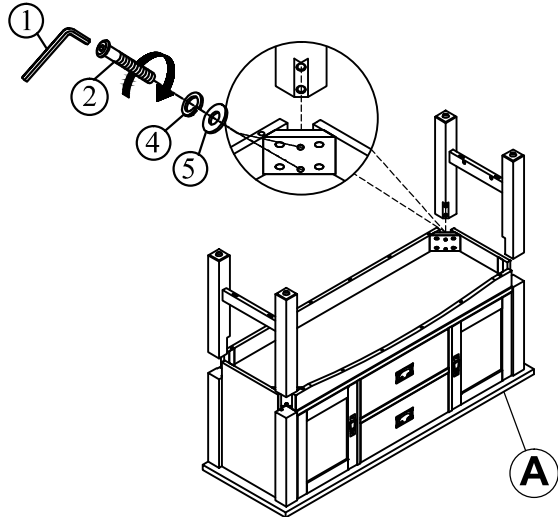

**Step 3:** Attach the Bottom Panel (B) to the Leg Assembly (C&D) using Flat Washer (5). Spring Washer (4). Bolt (3) and tighten with Allen Key (1)

Assembly is now complete. Thank you for your Purchase

